

SEATED CHORAL RISER SET

NO. 325

SEATING CAPACITY NOT USING THE FLOOR, 52.

SEATING CAPACITY WITH ONE ROW ON THE FLOOR, 72.

SEATING CAPACITY IS BASED ON 26" CHAIR SPACING.



C O R P O R A T I O N

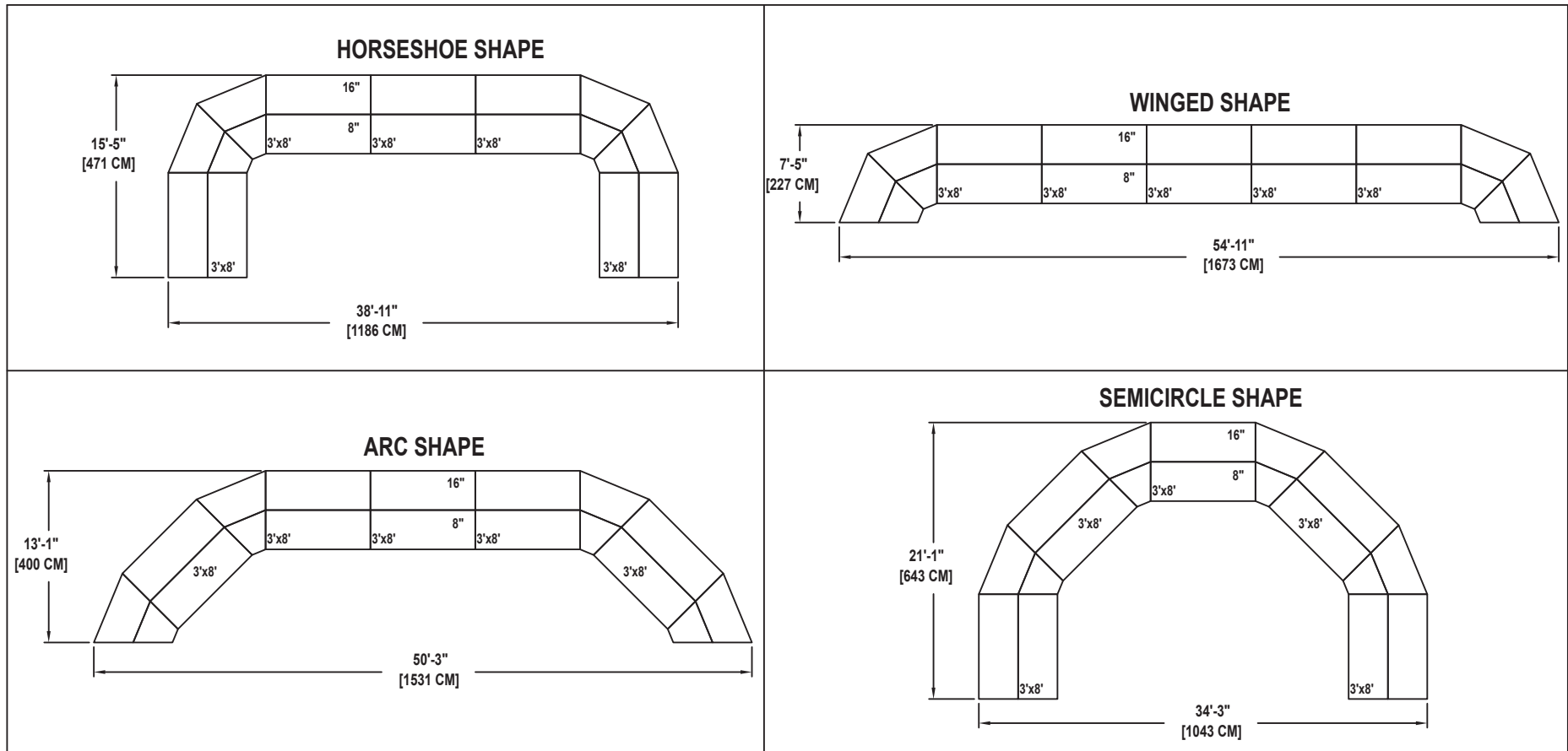

Drawing 100A311_A
Sheet 22 of 44



MUSIC EDUCATION AND PERFORMING ARTS

Owatonna Office: Phone 800.4WENGER (493-6437) Worldwide +1.507.455.4100 | Parts & Service 800.887.7145 | wengercorp.com | 555 Park Drive, PO Box 448 | Owatonna | MN 55060-0448

Syracuse Office: Phone 800.836.1885 Worldwide +1.315.451.3440 | jrclancy.com | 7041 Interstate Island Road | Syracuse | NY 13209-9713

ATHLETICS Phone 800.493.6437 | gearboss.com | 555 Park Drive, PO Box 448 | Owatonna | MN 55060-0448